

HACD系列
(高压用、小型化品)



◆特性

- 本公司独特的圆筒结构，性能优异。
- 通电时发出的声音微弱（支持静音）
- 与原来的TACB相比，体积平均缩小了35%。
- 主故障模式为开路。

◆用途

- 共振用（开关电源、逆变器电流、电视机的水平偏转电路）
- 滤波器用（逆变器电源）
- 缓冲电路用（IGBT、SSR、GTO等开关元件的保护）
- 音响用（电容器发出的声音很小）

◆规格表

编号	项 目	规 格		
1	工作温度范围	-40~+105℃		
2	额定电压	630V _{dc} 、1000V _{dc} 、1250V _{dc} 、1600V _{dc} 、2000V _{dc} 、2500V _{dc} 、3150V _{dc} 、4000V _{dc}		
3	额定静电容量范围	0.0033μF~1.5μF		
4	额定静电容量容差	±5%(J)		
5	额定纹波电流	(1) 100kHz正弦电流请参看标准品一览表。 (2) 100kHz之外的正弦电流请参看Fig. 9。 (3) 100kHz及正弦电流之外请确认温升后再使用。		
6	最大容许浪涌电流	额定静电容量(μF)×额定电压(V _{dc}) 但是，最大100A _{o-p} 以下为不重复		
7	最大容许脉冲电流	请参看表6。		
8	额定纹波电压	请参看标准品一览表。		
9	最大容许浪涌电压	额定电压(V _{dc})×1.5，但是不重复		
10	温升限值	请参看Fig. 1。 环境温度+85℃以下时，为15K以下。环境温度+105℃以下时，为7.5K以下。 但是，设计时考虑到偏差，分别设计成12K以下和6K以下。		
编号	项 目	规 格	测试方法	
11	额定静电容量	在规定的容差内	在1kHz下进行测量。	
12	损耗角正切	$C_R > 1 \mu F$: $(C_R \times 0.015 + 0.05)\%$ 以下	在1kHz下进行测量。	
		$C_R \leq 1 \mu F$: 0.05%以下		
13	绝缘电阻 (端子间)	0.33μF以下的产品	30000MΩ以上	
		超过0.33μF的产品	$\frac{10000}{C_R}$ MΩ以上	
14	耐电压	端子间	无异常	
15	耐湿负荷	外观	无明显异常	
		绝缘电阻 (端子间)	0.33μF以下的产品	10000MΩ以上
			超过0.33μF的产品	$\frac{3000}{C_R}$ MΩ以上
		损耗角正切	应为12号的值以下	
		静电容量变化率	测试前的值的±5%	
16	高温负荷	外观	与15号相同	
		绝缘电阻(端子间)	与15号相同	
		损耗角正切	与15号相同	
		静电容量变化率	与15号相同	

※表中的C_R为以μF为单位表示额定静电容量的值。

HACD 系列

◆标准品一览表

WV (Vdc)	Cap (μ F)	尺寸 (mm)					额定纹波电流 (Arms)	额定纹波电压 (Vac)	产品型号	原有产品型号 (请参考)
		W	H	T	F	ϕ d				
630	0.047	17.7	9.8	9.3	12.5	0.8	2.65	250	FHACD631V473JOLGZO	HACD2J473J
	0.056		10.4	10.0			FHACD631V563JOLGZO		HACD2J563J	
	0.068		11.0	10.5			FHACD631V683JOLGZO		HACD2J683J	
	0.082		11.6	11.1			FHACD631V823JOLGZO		HACD2J823J	
	0.1		12.3	11.7			FHACD631V104JOLGZO		HACD2J104J	
	0.12		13.1	12.5			FHACD631V124JOLGZO		HACD2J124J	
	0.15		14.1	13.5			FHACD631V154JOLGZO		HACD2J154J	
	0.18		15.1	14.4			FHACD631V184JOLGZO		HACD2J184J	
	0.22	13.8	13.2	FHACD631V224J1LHZO	HACD2J224J					
	0.27	14.9	14.2	FHACD631V274J1LHZO	HACD2J274J					
	0.33	16.1	15.3	FHACD631V334J1LHZO	HACD2J334J					
	0.39	17.1	16.3	FHACD631V394J1LHZO	HACD2J394J					
	0.47	18.5	17.6	FHACD631V474J1LHZO	HACD2J474J					
	0.56	19.9	18.9	FHACD631V564J1LHZO	HACD2J564J					
	0.68	19.0	18.1	FHACD631V684J2LEZO	HACD2J684J					
	0.82	20.5	19.6	FHACD631V824J2LEZO	HACD2J824J					
	1.0	22.3	21.3	FHACD631V105J2LEZO	HACD2J105J					
	1.2	24.2	23.0	FHACD631V125J2LEZO	HACD2J125J					
	1.5	26.7	25.4	FHACD631V155J2LEZO	HACD2J155J					
	1000	0.033	17.7	10.0	9.6	12.5	0.8		2.43	270
0.039		10.4		10.0	FHACD102V393JOLGZO			HACD3A393J		
0.047		11.0		10.5	FHACD102V473JOLGZO			HACD3A473J		
0.056		11.5		11.0	FHACD102V563JOLGZO			HACD3A563J		
0.068		12.2		11.7	FHACD102V683JOLGZO			HACD3A683J		
0.082		13.0		12.4	FHACD102V823JOLGZO			HACD3A823J		
0.1		13.9		13.3	FHACD102V104JOLGZO			HACD3A104J		
0.12		14.9		14.2	FHACD102V124JOLGZO			HACD3A124J		
0.15		13.7	13.1	FHACD102V154J1LHZO	HACD3A154J					
0.18		14.7	14.0	FHACD102V184J1LHZO	HACD3A184J					
0.22		15.8	15.1	FHACD102V224J1LHZO	HACD3A224J					
0.27		17.1	16.3	FHACD102V274J1LHZO	HACD3A274J					
0.33		18.6	17.7	FHACD102V334J1LHZO	HACD3A334J					
0.39		19.9	19.0	FHACD102V394J1LHZO	HACD3A394J					
0.47		18.9	18.0	FHACD102V474J2LEZO	HACD3A474J					
0.56		20.4	19.4	FHACD102V564J2LEZO	HACD3A564J					
0.68		22.1	21.1	FHACD102V684J2LEZO	HACD3A684J					
0.82		24.0	22.9	FHACD102V824J2LEZO	HACD3A824J					
1.0		26.2	25.0	FHACD102V105J2LEZO	HACD3A105J					
1.2		28.5	27.1	FHACD102V125J2LEZO	HACD3A125J					
1250	0.018	17.7	9.7	9.3	12.5	0.8	2.04	300	FHACD1C2V183JOLGZO	HACD3B183J
	0.022		10.4	9.9			FHACD1C2V223JOLGZO		HACD3B223J	
	0.027		11.0	10.5			FHACD1C2V273JOLGZO		HACD3B273J	
	0.033		11.6	11.1			FHACD1C2V333JOLGZO		HACD3B333J	
	0.039		12.3	11.7			FHACD1C2V393JOLGZO		HACD3B393J	
	0.047		13.0	12.4			FHACD1C2V473JOLGZO		HACD3B473J	
	0.056		13.8	13.2			FHACD1C2V563JOLGZO		HACD3B563J	
	0.068		14.8	14.2			FHACD1C2V683JOLGZO		HACD3B683J	
	0.082	13.3	12.7	FHACD1C2V823J1LHZO	HACD3B823J					
	0.1	14.3	13.6	FHACD1C2V104J1LHZO	HACD3B104J					
	0.12	15.3	14.6	FHACD1C2V124J1LHZO	HACD3B124J					
	0.15	16.7	15.9	FHACD1C2V154J1LHZO	HACD3B154J					
	0.18	17.9	17.1	FHACD1C2V184J1LHZO	HACD3B184J					
	0.22	19.5	18.6	FHACD1C2V224J1LHZO	HACD3B224J					
	0.27	18.5	17.7	FHACD1C2V274J2LEZO	HACD3B274J					
	0.33	20.1	19.2	FHACD1C2V334J2LEZO	HACD3B334J					
	0.39	21.6	20.6	FHACD1C2V394J2LEZO	HACD3B394J					
	0.47	23.4	22.3	FHACD1C2V474J2LEZO	HACD3B474J					
	0.56	25.3	24.1	FHACD1C2V564J2LEZO	HACD3B564J					
	0.68	27.6	26.3	FHACD1C2V684J2LEZO	HACD3B684J					
0.82	23.2	22.1	FHACD1C2V824JTLJZO	HACD3B824J						
1.0	25.4	24.2	FHACD1C2V105JTLJZO	HACD3B105J						
1.2	27.5	26.2	FHACD1C2V125JTLJZO	HACD3B125J						

- (1) 额定纹波电流: 环境温度85℃以下、100kHz时的正弦电流
 (2) 额定纹波电压: 商用频率 (50Hz/60Hz) 时

HACD 系列

◆标准品一览表

WV (Vdc)	Cap (μ F)	尺寸 (mm)					额定纹波电流 (Arms)	额定纹波电压 (Vac)	产品型号	原有产品型号 (请参考)
		W	H	T	F	ϕ d				
1600	0.0068	19.7	10.0	9.5	15.0	0.8	1.49	350	FHACD162V682JKLDZO	HACD3C682J
	0.0082		10.6	10.1			FHACD162V822JKLDZO		HACD3C822J	
	0.01		11.2	10.6			FHACD162V103JKLDZO		HACD3C103J	
	0.012		11.8	11.2			FHACD162V123JKLDZO		HACD3C123J	
	0.015		12.6	12.0			FHACD162V153JKLDZO		HACD3C153J	
	0.018		13.4	12.8			FHACD162V183JKLDZO		HACD3C183J	
	0.022		14.4	13.7			FHACD162V223JKLDZO		HACD3C223J	
	0.027		15.0	14.3			FHACD162V273JKLDZO		HACD3C273J	
	0.033		16.3	15.5			FHACD162V333JKLDZO		HACD3C333J	
	0.039		13.0	12.4			FHACD162V393J1LHZO		HACD3C393J	
	0.047	13.8	13.2	FHACD162V473J1LHZO	HACD3C473J					
	0.056	14.7	14.0	FHACD162V563J1LHZO	HACD3C563J					
	0.068	15.8	15.1	FHACD162V683J1LHZO	HACD3C683J					
	0.082	17.0	16.2	FHACD162V823J1LHZO	HACD3C823J					
	0.1	18.4	17.6	FHACD162V104J1LHZO	HACD3C104J					
	0.12	17.2	16.4	FHACD162V124J2LEZO	HACD3C124J					
	0.15	18.9	18.0	FHACD162V154J2LEZO	HACD3C154J					
	0.18	20.4	19.4	FHACD162V184J2LEZO	HACD3C184J					
	0.22	22.2	21.1	FHACD162V224J2LEZO	HACD3C224J					
	0.27	24.2	23.1	FHACD162V274J2LEZO	HACD3C274J					
0.33	26.5	25.3	FHACD162V334J2LEZO	HACD3C334J						
2000	0.0033	19.7	9.3	8.9	15.0	0.8	0.73	350	FHACD202V332JKLDZO	HACD3D332J
	0.0039		9.7	9.2			FHACD202V392JKLDZO		HACD3D392J	
	0.0047		10.2	9.7			FHACD202V472JKLDZO		HACD3D472J	
	0.0056		10.9	10.4			FHACD202V562JKLDZO		HACD3D562J	
	0.0068		11.8	11.2			FHACD202V682JKLDZO		HACD3D682J	
	0.0082		12.6	12.0			FHACD202V822JKLDZO		HACD3D822J	
	0.01		13.5	12.9			FHACD202V103JKLDZO		HACD3D103J	
	0.012		14.4	13.7			FHACD202V123JKLDZO		HACD3D123J	
	0.015		15.6	14.9			FHACD202V153JKLDZO		HACD3D153J	
	0.018		16.7	16.0			FHACD202V183JKLDZO		HACD3D183J	
	0.022	13.1	12.5	FHACD202V223J1LHZO	HACD3D223J					
	0.027	14.0	13.4	FHACD202V273J1LHZO	HACD3D273J					
	0.033	15.1	14.4	FHACD202V333J1LHZO	HACD3D333J					
	0.039	16.1	15.3	FHACD202V393J1LHZO	HACD3D393J					
	0.047	17.3	16.5	FHACD202V473J1LHZO	HACD3D473J					
	0.056	18.6	17.7	FHACD202V563J1LHZO	HACD3D563J					
	0.068	17.5	16.6	FHACD202V683J2LEZO	HACD3D683J					
	0.082	18.8	18.0	FHACD202V823J2LEZO	HACD3D823J					
	0.1	20.5	19.5	FHACD202V104J2LEZO	HACD3D104J					
	0.12	22.1	21.1	FHACD202V124J2LEZO	HACD3D124J					
0.15	24.4	23.2	FHACD202V154J2LEZO	HACD3D154J						
0.18	26.4	25.2	FHACD202V184J2LEZO	HACD3D184J						
0.22	22.6	21.5	FHACD202V224JTLJZO	HACD3D224J						
0.27	24.7	23.5	FHACD202V274JTLJZO	HACD3D274J						
0.33	27.0	25.7	FHACD202V334JTLJZO	HACD3D334J						
2500	0.015	34.7	11.7	11.2	30.0	1.0	2.11	500	FHACD252V153JRLQZO	HACD3E153J
	0.018		12.6	12.0			FHACD252V183JRLQZO		HACD3E183J	
	0.022		13.7	13.0			FHACD252V223JRLQZO		HACD3E223J	
	0.027		14.9	14.2			FHACD252V273JRLQZO		HACD3E273J	
	0.033		16.2	15.4			FHACD252V333JRLQZO		HACD3E333J	
	0.039		17.4	16.6			FHACD252V393JRLQZO		HACD3E393J	
	0.047		18.9	18.0			FHACD252V473JRLQZO		HACD3E473J	
	0.056		20.4	19.5			FHACD252V563JRLQZO		HACD3E563J	
	0.068		22.3	21.3			FHACD252V683JRLQZO		HACD3E683J	
	0.082		24.3	23.1			FHACD252V823JRLQZO		HACD3E823J	
	0.1		26.6	25.4			FHACD252V104JRLQZO		HACD3E104J	

(1) 额定纹波电流：环境温度85℃以下、100kHz时的正弦电流

(2) 额定纹波电压：商用频率（50Hz/60Hz）时

HACD 系列

◆标准品一览表

WV (Vdc)	Cap (μ F)	尺寸 (mm)					额定纹波电流 (Arms)	额定纹波电压 (Vac)	产品型号	原有产品型号 (请参考)					
		W	H	T	F	ϕ d									
3150	0.0068	34.7	11.5	11.0	30.0	1.0	1.64	630	FHACD3B2V682JRLQZO	HACD3F682J					
	0.0082		12.4	11.8			1.80		FHACD3B2V822JRLQZO	HACD3F822J					
	0.01		13.4	12.8			1.99		FHACD3B2V103JRLQZO	HACD3F103J					
	0.012		14.4	13.7			2.18		FHACD3B2V123JRLQZO	HACD3F123J					
	0.015		15.8	15.1			2.44		FHACD3B2V153JRLQZO	HACD3F153J					
	0.018		17.1	16.3			2.67		FHACD3B2V183JRLQZO	HACD3F183J					
	0.022		18.7	17.8			2.95		FHACD3B2V223JRLQZO	HACD3F223J					
	0.027		20.5	19.5			3.27		FHACD3B2V273JRLQZO	HACD3F273J					
	0.033		22.4	21.4			3.62		FHACD3B2V333JRLQZO	HACD3F333J					
	0.039		24.2	23.1			3.93		FHACD3B2V393JRLQZO	HACD3F393J					
	0.047		26.4	25.1			4.31		FHACD3B2V473JRLQZO	HACD3F473J					
	4000		0.0039	34.7			11.2		10.6	30.0	1.0	1.63	720	FHACD402V392JRLQZO	HACD3G392J
			0.0047				12.0		11.4			1.79		FHACD402V472JRLQZO	HACD3G472J
0.0056		12.8	12.2		1.95	FHACD402V562JRLQZO	HACD3G562J								
0.0068		13.9	13.2		2.15	FHACD402V682JRLQZO	HACD3G682J								
0.0082		15.0	14.3		2.36	FHACD402V822JRLQZO	HACD3G822J								
0.01		16.3	15.6		2.60	FHACD402V103JRLQZO	HACD3G103J								
0.012		17.7	16.8		2.85	FHACD402V123JRLQZO	HACD3G123J								
0.015		19.5	18.6		3.19	FHACD402V153JRLQZO	HACD3G153J								
0.018		21.2	20.2		3.49	FHACD402V183JRLQZO	HACD3G183J								
0.022		23.2	22.1		3.86	FHACD402V223JRLQZO	HACD3G223J								
0.027		25.5	24.2		4.28	FHACD402V273JRLQZO	HACD3G273J								

- (1) 额定纹波电流: 环境温度85℃以下、100kHz时的正弦电流
 (2) 额定纹波电压: 商用频率 (50Hz/60Hz) 时

◆外观尺寸图

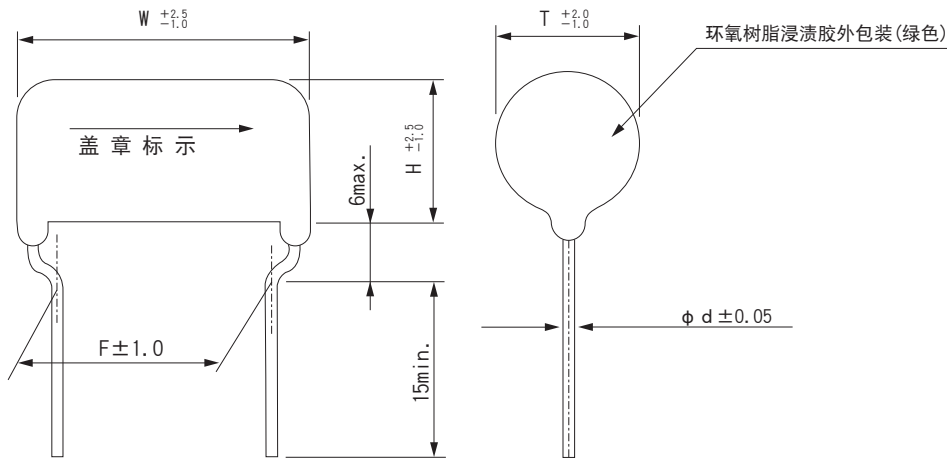

◆标示

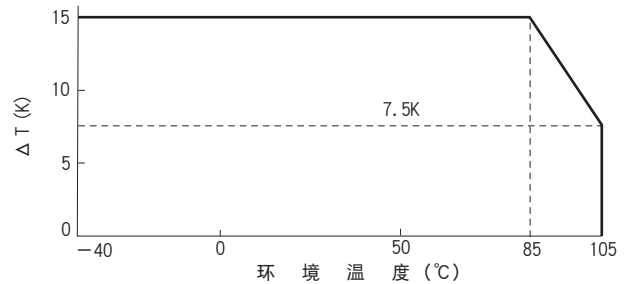

Fig. 1 环境温度与温升限值

表6 最大容许脉冲电流 (85°Cmax、重复使用)

(Ao-p)

V _{ac} (Code) 脉冲周期 μF (Code)	630 (2J)			1000 (3A)			1250 (3B)			1600 (3C)			V _{ac} (Code) 脉冲周期 μF (Code)	2000 (3D)			2500 (3E)			3150 (3F)			4000 (3G)					
	1kHz (1,000 μsec)	10kHz (100 μsec)	100kHz (10 μsec)	1kHz (1,000 μsec)	10kHz (100 μsec)	100kHz (10 μsec)	1kHz (1,000 μsec)	10kHz (100 μsec)	100kHz (10 μsec)	1kHz (1,000 μsec)	10kHz (100 μsec)	100kHz (10 μsec)		1kHz (1,000 μsec)	10kHz (100 μsec)	100kHz (10 μsec)	1kHz (1,000 μsec)	10kHz (100 μsec)	100kHz (10 μsec)	1kHz (1,000 μsec)	10kHz (100 μsec)	100kHz (10 μsec)	1kHz (1,000 μsec)	10kHz (100 μsec)	100kHz (10 μsec)			
0.0068 (682)													10.1	8.2	6.5	0.0033 (332)	8.2	6.7	5.3									
0.0082 (822)													11.2	9.1	7.2	0.0039 (392)	8.9	7.2	5.7									
0.01 (103)													12.6	10.3	8.1	0.0047 (472)	9.7	7.9	6.2					10.9	8.8	7.0		
0.012 (123)													14.2	11.5	9.1	0.0056 (562)	10.7	8.7	6.9					12.0	9.7	7.7		
0.015 (153)													16.6	13.5	10.6	0.0068 (682)	12.0	9.7	7.7			14.7	11.9	9.4	13.5	11.0	8.6	
0.018 (183)								11.4	9.3	7.3			18.9	15.4	12.1	0.0082 (822)	13.5	10.9	8.6			16.7	13.6	10.7	15.1	12.3	9.7	
0.022 (223)								12.9	10.5	8.3			22.1	18.0	14.2	0.01 (103)	15.4	12.5	9.9			19.4	15.8	12.4	17.4	14.1	11.1	
0.027 (273)								14.7	12.0	9.4			26.0	21.2	16.7	0.012 (123)	17.5	14.2	11.2			22.3	18.2	14.3	20.0	16.3	12.8	
0.033 (333)						13.4	10.9	8.6	16.9	13.8	10.9		30.8	25.0	19.8	0.015 (153)	20.7	16.8	13.3	19.9	16.2	12.8	26.7	21.7	17.1	23.3	19.0	15.0
0.039 (393)						15.0	12.2	9.6	19.2	15.6	12.3		37.5	30.3	23.8	0.018 (183)	23.9	19.4	15.3	23.0	18.7	14.8	31.1	25.3	20.0	27.1	22.0	17.4
0.047 (473)	15.0	12.2	9.6	17.1	13.9	11.0	22.1	18.0	14.2	20.2	16.4	13.0				0.022 (223)	14.5	11.8	9.3	27.1	22.0	17.4	37.0	30.1	23.7	32.6	26.5	20.9
0.056 (563)	17.0	13.8	10.9	19.5	15.8	12.5	25.4	20.7	16.3	23.1	18.8	14.9				0.027 (273)	16.7	13.6	10.7	32.1	26.1	20.6	44.3	36.0	28.4	38.2	31.1	24.5
0.068 (683)	19.6	16.0	12.6	22.6	18.4	14.5	29.9	24.3	19.2	27.1	22.0	17.4				0.033 (333)	19.4	15.8	12.4	38.2	31.1	24.5	53.1	43.2	34.1			
0.082 (823)	22.7	18.5	14.6	26.3	21.4	16.9	34.4	28.0	22.1	31.7	25.8	20.3				0.039 (393)	22.0	17.9	14.1	44.3	36.0	28.4	61.9	50.4	39.7			
0.1 (104)	26.7	21.7	17.1	31.0	25.2	19.9	39.9	33.0	26.1	37.6	30.6	24.1				0.047 (473)	25.6	20.8	16.4	52.4	42.7	33.7	73.6	59.9	47.3			
0.12 (124)	31.0	25.2	19.9	36.3	29.5	23.3	45.4	37.5	29.6	42.6	34.6	27.1				0.056 (563)	29.6	24.1	19.0	61.6	50.1	39.5						
0.15 (154)	37.6	30.6	24.1	43.7	35.8	28.1	54.4	45.4	35.4	51.6	42.6	33.1				0.068 (683)	36.0	29.3	23.2	73.8	60.0	47.3						
0.18 (184)	44.2	36.0	28.4	51.4	41.6	32.4	64.4	53.4	41.4	61.6	50.6	39.1				0.082 (823)	43.2	34.4	27.2	88.0	71.6	56.5						
0.22 (224)	53.4	43.0	34.0	61.4	49.4	38.4	76.4	63.4	49.4	73.6	60.6	47.1				0.1 (104)	51.8	42.1	33.2	100.0	86.4	68.2						
0.27 (274)	63.4	51.4	40.4	73.4	58.4	45.4	89.4	74.4	58.4	86.6	71.6	55.1				0.12 (124)	61.2	49.8	39.3									
0.33 (334)	75.4	61.4	48.4	86.4	69.4	53.4	103.4	86.4	67.4	100.6	84.6	65.1				0.15 (154)	73.6	60.6	47.3									
0.39 (394)	89.4	73.4	57.4	100.4	81.4	62.4	119.4	100.4	79.4	116.6	98.6	77.1				0.18 (184)	86.6	71.6	56.5									
0.47 (474)	105.4	85.4	67.4	119.4	96.4	75.4	137.4	116.4	92.4	134.6	113.6	89.1				0.22 (224)	100.0	86.4	68.2									
0.56 (564)	123.4	99.4	78.4	140.4	113.4	88.4	157.4	134.4	106.4	154.6	131.6	103.1				0.27 (274)	116.6	98.6	77.1									
0.68 (684)	143.4	115.4	91.4	164.4	133.4	103.4	181.4	156.4	124.4	178.6	154.6	121.1				0.33 (334)	134.6	113.6	89.1									
0.82 (824)	167.4	135.4	105.4	191.4	156.4	121.4	209.4	181.4	147.4	206.6	181.6	143.1				0.39 (394)	154.6	131.6	103.1									
1.0 (105)	195.4	157.4	123.4	223.4	181.4	141.4	241.4	209.4	167.4	238.6	209.6	163.1				0.47 (474)	178.6	154.6	121.1									
1.2 (125)	227.4	181.4	143.4	254.4	207.4	161.4	273.4	237.4	191.4	270.6	237.6	187.1				0.56 (564)	206.6	181.6	143.1									
1.5 (155)	267.4	213.4	167.4	295.4	237.4	187.4	313.4	273.4	223.4	310.6	273.6	217.1				0.68 (684)	238.6	209.6	163.1									

◆各频率的额定纹波电流 (85°C max.)... (Fig.9)

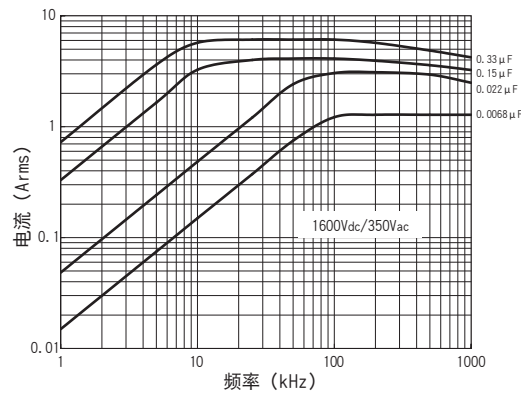
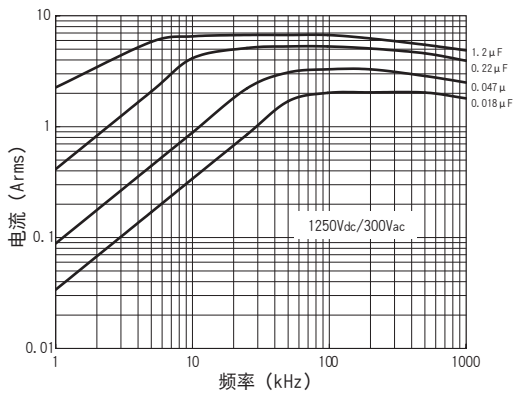
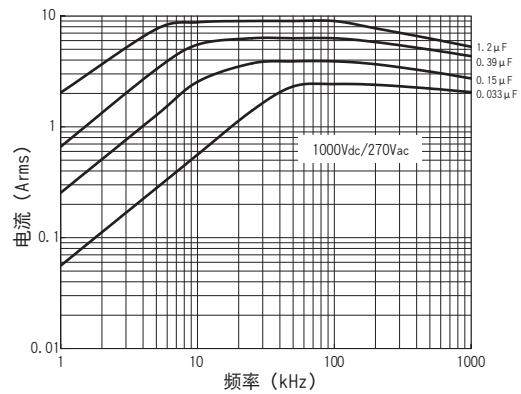
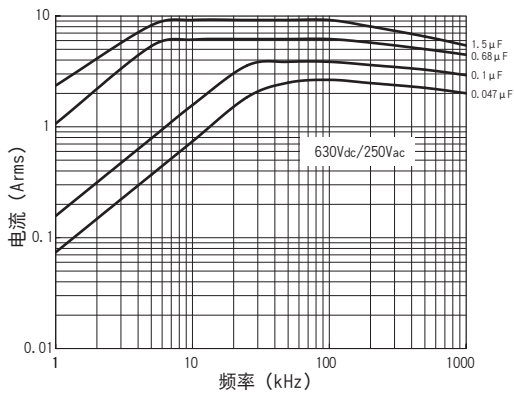

HACD 系列

◆各频率的额定纹波电流（85°C max.）…(Fig. 9)

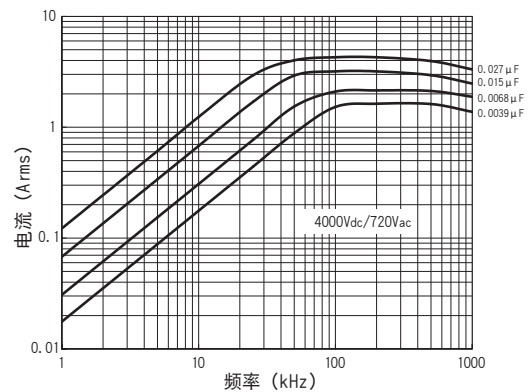
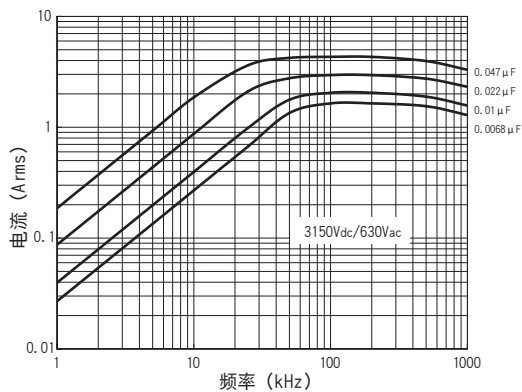
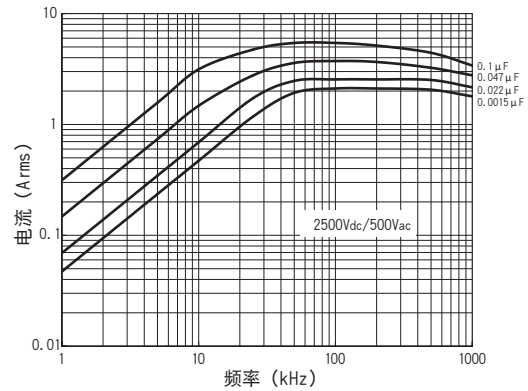
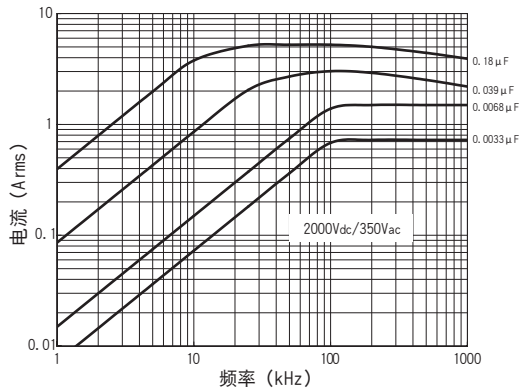

本资料选择各额定电压的典型容量值，制作各频率的电流曲线。通常，静电容量越大，流过的电流越大。但因结构的不同（引线节距），存在即使静电容量变大，流过的电流也会变小的情形。因此，在研讨本资料所述之外的产品时，请联系我们。

◆使用注意事项

- (1) 最大容许脉冲电流请根据脉冲周期在表6所示的值以下进行使用。
- (2) 在最大容许脉冲电流下使用时，请确认基于脉冲电流的有效值在标准品一览表的值以下，且在Fig. 1的温升限值以下。
- (3) 最大容许脉冲电流的周期在以下波形时，为 $1/T_1$ 。

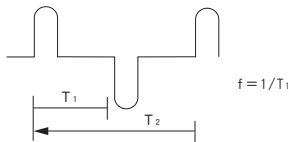

- (4) 表6为假定连续通电使用10年时的值。为表6之外的周期或非连续通电等时，请咨询。